

IDK-LOK

Fittings & Valves

Clean Fittings

No.06-2
September 2014



CRN KCHNP CE

Clean Weld Fittings

Mini Elbow
RWML 04



Auto Butt Weld Long Elbow
RWL-A 08



Auto Butt Weld Short Gland
RSG-A 14



Mini Tee
RWMT 04



Auto Butt Weld Long Tee
RWT-A 08



Auto Butt Weld Long Gland
RLG-A 14



Mini Cross
RWMX 04



Auto Butt Weld Long Cross
RWX-A 09



Male Gland
RGM 15



Mini Reducing Elbow
RWML 05



Auto Butt Weld Long Reducing Tee
RWT-A 09



Auto Butt Weld Mini Short Gland
RMSG-A 15



Mini Reducing Tee
RWMT 05



Auto Butt Weld Union
RWU-A 10



Socket Gland
RGS 16



Mini Reducing Union
RWMU 05



Auto Butt Weld Reducing Union
RWU-A 10



Reducing Socket Gland
RGS 16



Long Elbow
RWL 06



Short Socket Gland
RGS 16



Metal Gasket Face-Seal Fittings

Long Tee
RWT 06



Short Gland
RSG 12



Tube Adapter Gland
RGT 17



Long Cross
RWX 06



Mini Short Gland
RMSG 12



Blind Gland
RBG 17



Long Reducing Tee
RWT 07



Long Gland
RLG 13



Coupling
RC 17



Long Reducing Union
RWU 07



Mini Long Gland
RMLG 13



Union
RU 18



Union Elbow RL		18	Tube Butt Weld Bulkhead Connector RBT		22	Gasket RGK		26
Union Tee RT		18	Swivel Female / Male Union RSMU		23	Gasket Retainer RGKT		26
Union Cross RX		19	Swivel Female Union RSU		23	High Flow Gland RHG		27
Reducing Union RUR		19	Swivel Male NPT Connector RSMC		23	High Flow Reducer RHR		27
Bulkhead Union RUB		19	Swivel Female NPT Connector RSCF		24	Auto Butt Weld High Flow Reducer RHR-A		27
Tube Fitting Connector RDC		20	Swivel Tube Fitting Connector RSD		24	High Flow Bulkhead Reducer RHUB		28
Tube Fitting Bulkhead Connector RDCB		20	Swivel Elbow RSL		24	High Flow Union Elbow RHL		28
Male NPT Connector RMC-N		21	Swivel Tee RST		25	High Flow Union Tee RHT		28
Male NPT Elbow RLM-N		21	Female Nut RFN		25	High Flow Female Nut RHFN		29
Straight thread O-Ring Seal Male Connector RMC-UO		21	Male Nut RMN		25	High Flow Male Nut RHMN		29
Female NPT Connector RCF-N		22	Plug RP		26	Tube Fitting to Auto Butt Weld Connector DATW		29
Bulkhead Male NPT Connector RMCB-N		22	Cap RC		26			

Pressure Rating

The informed pressure rating in this catalogue is obtained by the calculation with the allowable stress 20,000 psig (1,378 bar) of stainless steel 316 at -20 (-28) to 100 (37) according to ASME B31.3 and B31.1 code.

The pressure derating factors are greater than 100 (37) shall be determined from these pressure code and is listed in the table 1.

To obtain the adequate pressure rating at the temperature is higher than the 100 (37) in accordance with ASME B31.3 and B31.1 code, that shall be multiply the pressure rating on this catalogue by the factor in the table 1.

Table 1. Derating Factor

Material	SS 316	SS 316L
Temperature ()	Derating Factor	
-20 (-28) ~ 100 (37)	1.00	1.00
~ 200 (93)	1.00	0.83
~ 400 (204)	0.96	0.77
~ 600 (315)	0.85	0.67
~ 800 (426)	0.79	0.62
~ 1000 (537)	0.76	0.56

Material

Material	Designation	Specificatoin	
		Bar stock	Forging
Stainless Steel 316	S	ASME SA479 ASTM A479 / A276	ASME SA182 ASTM A182
Stainless Steel 316L	L		
Stainless Steel 316L Single Vacuum Melting	SL		
Stainless Steel 316L Double Vacuum Melting	DL		

Cleaning & Packing

Passivation is done in accordance with ASTM A380 and the Ultra-sonic cleaning in clean room (class 100) is implemented with resistivity over 18MΩ D.I water after finishing the passivation for precision cleaning. After Cleaning, the product shall be double packed in the clean room within anti-static polyethylene bags where let high purity nitrogen in.

Surface Roughness

Grade	Designation	Roughness, Ra
BA	Nil	10 µin. (0.25µm)

Feature

- Proper design for tube fitting in the small space
- Optimised gap between the parts for tube fitting
- Flow capacity to be equivalent to the conventional big size welding fitting

Rounded Egde : all edges of the product are rounded for safety handling and preventing to damage the other products

Material Heatcode : marked on the product for easy raw material traceability

Laser Marking : Part number, material and the grade of surface roughness are marked on the body for easy identification



Standard surface roughness is 10 µin. (0.25µm)

For automatic tube butt welding, integral filler ring can be applicable for proper alignment

Sharp and burr-free tube end :

Radiused Junction : pockets and entrapment zones in the junction portion are eliminated for the smooth flow transition

Accurately machined diameter dimension conforms to tube diameter

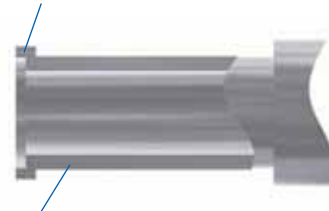
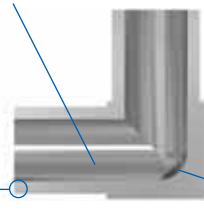

Mini Elbow

RWML

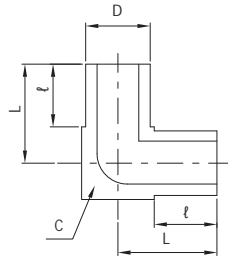

Part No.	D Tube O.D.	Wall Thickness	e	L	C Cubic Body	Working Pressure
Fractional	in.		mm (in.)		in.	psig (barg)
RWML-2	1/8	0.028	6.4 (0.25)	10.4 (0.41)	5/16	8500 (585)
RWML-4	1/4	0.035		11.9 (0.47)	7/16	5100 (351)
RWML-6	3/8	0.049		13.5 (0.53)	9/16	3300 (227)
RWML-8	1/2			13.5 (0.53)	9/16	3700 (254)
Metric	mm		mm (in.)		Flat (in.)	barg (psig)
RWML-6M	6	1	6.4 (0.25)	10.4 (0.41)	5/16	420 (6095)
RWML-8M	8			11.9 (0.47)	7/16	310 (4499)
RWML-10M	10			11.9 (0.47)	7/16	240 (3483)
RWML-12M	12			13.5 (0.53)	9/16	200 (2902)

Mini Tee

RWMT

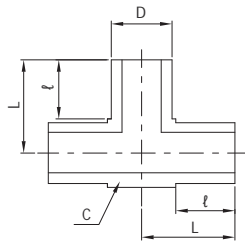

Part No.	D Tube O.D.	Wall Thickness	e	L	C Cubic Body	Working Pressure
Fractional	in.		mm (in.)		in.	psig (barg)
RWMT-2	1/8	0.028	6.4 (0.25)	10.4 (0.41)	5/16	8500 (585)
RWMT-4	1/4	0.035		11.9 (0.47)	7/16	5100 (351)
RWMT-6	3/8	0.049		13.5 (0.53)	9/16	3300 (227)
RWMT-8	1/2			13.5 (0.53)	9/16	3700 (254)
Metric	mm		mm (in.)		Flat (in.)	barg (psig)
RWMT-6M	6	1	6.4 (0.25)	10.4 (0.41)	5/16	420 (6095)
RWMT-8M	8			11.9 (0.47)	7/16	310 (4499)
RWMT-10M	10			11.9 (0.47)	7/16	240 (3483)
RWMT-12M	12			13.5 (0.53)	9/16	200 (2902)

Mini Cross

RWMX

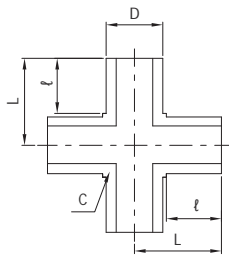

Part No.	D Tube O.D.	Wall Thickness	e	L	C Cubic Body	Working Pressure
Fractional	in.		mm (in.)		in.	psig (barg)
RWMX-2	1/8	0.028	6.4 (0.25)	10.4 (0.41)	5/16	8500 (585)
RWMX-4	1/4	0.035		11.9 (0.47)	7/16	5100 (351)
RWMX-6	3/8	0.049		13.5 (0.53)	9/16	3300 (227)
RWMX-8	1/2			13.5 (0.53)	9/16	3700 (254)
Metric	mm		mm (in.)		Flat (in.)	barg (psig)
RWMX-6M	6	1	6.4 (0.25)	10.4 (0.41)	5/16	420 (6095)
RWMX-8M	8			11.9 (0.47)	7/16	310 (4499)
RWMX-10M	10			11.9 (0.47)	7/16	240 (3483)
RWMX-12M	12			13.5 (0.53)	9/16	200 (2902)

Mini Reducing Elbow

RWML

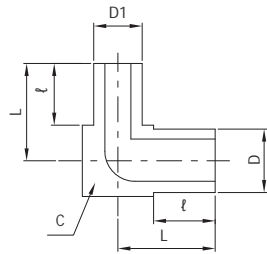

Part No.	D Tube O.D.	Wall Thickness	D1 Tube O.D.	Wall Thickness	ℓ	L	C Cubic Body	Working Pressure
Fractional	in.				mm (in.)		in.	psig (barg)
RWML6-4	3/8	0.035	1/4	0.035	6.4 (0.25)	11.9 (0.47)	7/16	3300 (227)
RWML8-4	1/2	0.049				13.5 (0.53)		3700 (254)
RWML8-6			3/8			3300 (227)		
Metric	mm				mm (in.)		in.	barg (psig)
RWML8M-6M	8	1	6	1	6.4 (0.25)	11.9 (0.47)	7/16	310 (4499)
RWML10M-6M	10					240 (3483)		
RWML12M-6M	12		8			13.5 (0.53)	9/16	200 (2902)
RWML12M-8M								

Mini Reducing Tee

RWMT

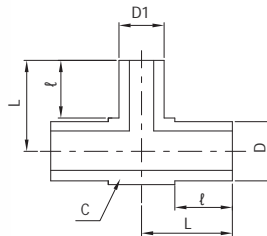

Part No.	D Tube O.D.	Wall Thickness	D1 Tube O.D.	Wall Thickness	ℓ	L	C Cubic Body	Working Pressure
Fractional	in.				mm (in.)		in.	psig (barg)
RWMT6-4	3/8	0.035	1/4	0.035	6.4 (0.25)	11.9 (0.47)	7/16	3300 (227)
RWMT8-4	1/2	0.049				13.5 (0.53)		3700 (254)
RWMT8-6			3/8			3300 (227)		
Metric	mm				mm (in.)		in.	barg (psig)
RWMT8M-6M	8	1	6	1	6.4 (0.25)	11.9 (0.47)	7/16	310 (4499)
RWMT10M-6M	10					240 (3483)		
RWMT12M-6M	12		8			13.5 (0.53)	9/16	200 (2902)
RWMT12M-8M								

Mini Reducing Union

RWMU

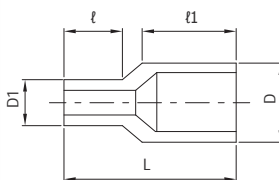

Part No.	D Tube O.D.	Wall Thickness	D1 Tube O.D.	Wall Thickness	L	ℓ	ℓ1	Working Pressure
Fractional	in.				mm (in.)			psig (barg)
RWMU4-2	1/4	0.035	1/8	0.028	19.05 (0.75)	10.41 (0.41)	6.35 (0.25)	5100 (351)
RWMU6-4	3/8		1/4	0.035				3300 (227)
RWMU8-4	1/2	0.049			3/8			
RWMU8-6								
Metric	mm				mm (in.)			barg (psig)
RWMU8M-6M	8	1	6	1	19.05 (0.75)	10.41 (0.41)	6.35 (0.25)	310 (4499)
RWMU10M-8M	10		240 (3483)					
RWMU12M-8M	12		8	10				200 (2902)
RWMU12M-10M								

Long Elbow

RWL

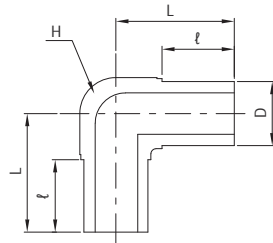

Part No.	D Tube Size	Wall Thickness	ℓ	L	H Hex. Body	Working Pressure
Fractional	in.		mm (in.)		in.	psig (barg)
RWL-4	1/4	0.035	19.0 (0.75)	31.2 (1.23)	7/16	5100 (351)
RWL-6	3/8			30.5 (1.20)		3300 (227)
RWL-8	1/2	0.049		34.0 (1.34)	11/16	3700 (254)
RWL-12	3/4		37.1 (1.46)	15/16	2400 (165)	
RWL-16	1	0.065	24.4 (0.94)	47.0 (1.85)		1 1/4
Metric	mm		mm (in.)		Flat (in.)	barg (psig)
RWL-6M	6	1	19.0 (0.75)	31.2 (1.23)	7/16	420 (6095)
RWL-8M	8			310 (4499)		
RWL-10M	10			240 (3483)		
RWL-12M	12			200 (2902)		
RWL-18M	18	1.5	37.6 (1.48)	15/16		

Long Tee

RWT

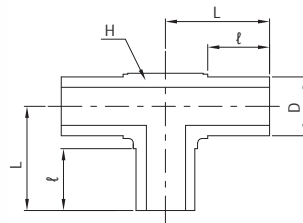

Part No.	D Tube Size	Wall Thickness	ℓ	L	H Hex. Body	Working Pressure
Fractional	in.		mm (in.)		in.	psig (barg)
RWT-4	1/4	0.035	19.0 (0.75)	31.2 (1.23)	7/16	5100 (351)
RWT-6	3/8			30.5 (1.20)		3300 (227)
RWT-8	1/2	0.049		34.0 (1.34)	11/16	3700 (254)
RWT-12	3/4		37.1 (1.46)	15/16	2400 (165)	
RWT-16	1	0.065	24.4 (0.94)	47.0 (1.85)		1 1/4
Metric	mm		mm (in.)		Flat (in.)	barg (psig)
RWT-6M	6	1	19.0 (0.75)	31.2 (1.23)	7/16	420 (6095)
RWT-8M	8			310 (4499)		
RWT-10M	10			240 (3483)		
RWT-12M	12			200 (2902)		
RWT-18M	18	1.5	37.6 (1.48)	15/16		

Long Cross

RWX

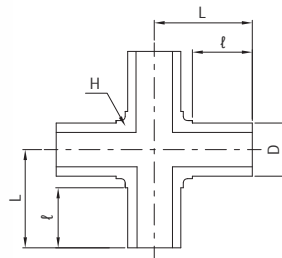

Part No.	D Tube Size	Wall Thickness	ℓ	L	H Hex. Body	Working Pressure
Fractional	in.		mm (in.)		in.	psig (barg)
RWX-4	1/4	0.035	19.0 (0.75)	31.2 (1.23)	7/16	5100 (351)
RWX-6	3/8			30.5 (1.20)		3300 (227)
RWX-8	1/2	0.049		34.0 (1.34)	11/16	3700 (254)
Metric	mm		mm (in.)		Flat (in.)	barg (psig)
RWX-6M	6	1	19.0 (0.75)	31.2 (1.23)	7/16	420 (6095)
RWX-8M	8			310 (4499)		
RWX-10M	10			240 (3483)		
RWX-12M	12			200 (2902)		

Long Reducing Tee

RWT

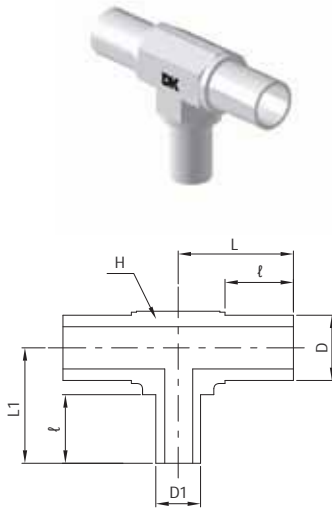

Part No.	D Tube Size	Wall Thickness	D1 Tube Size	Wall Thickness	ℓ	L	L1	H Hex. Body	Working Pressure
Fractional	in.				mm (in.)			in.	psig (barg)
RWT6-4	3/8	0.035	1/4	0.035	0.75 (19.0)	30.5 (1.20)	31.2 (1.23)	7/16	3300 (227)
RWT8-4	1/2	0.049				34.0 (1.34)	34.0 (1.34)		
RWT8-6			3/8			34.3 (1.35)	15/16	2400 (165)	
RWT12-6	3/4	0.049	1/4			37.1 (1.46)			37.6 (1.48)
RWT12-4									
Metric	mm				mm (in.)			in.	barg (psig)
RWT8M-6M	8	1	6	1	19.0 (0.75)	31.3 (1.23)	31.3 (1.23)	7/16	310 (4499)
RWT10M-6M	10		8			11/16	240 (3483)		
RWT10M-8M			6					200 (2902)	
RWT12M-6M	12		8						
RWT12M-8M									

Long Reducing Union

RWU

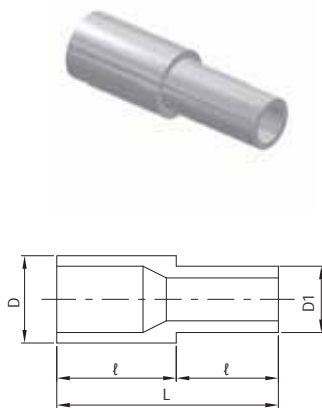

Part No.	D Tube Size	Wall Thickness	D1 Tube Size	Wall Thickness	L	ℓ	Working Pressure
Fractional	in.				mm (in.)		psig (barg)
RWU6-4	3/8	0.035	1/4	0.035	38.1 (1.50)	19.0 (0.75)	3300 (227)
RWU8-4	1/2	0.049					
RWU8-6			3/4	0.049			2400 (165)
RWU12-8	1/2						
RWU16-8	1	0.065	3/4				
RWU16-12							
Metric	mm				mm (in.)		barg (psig)
RWU10M-6M	10	1	6	1	38.1 (1.50)	19.0 (0.75)	240 (3483)
RWU10M-8M			8				
RWU12M-6M	12		6				200 (2902)
RWU12M-8M			8				
RWU12M-10M		10					
RWU18M-6M	18	1.5	6	1.5			
RWU18M-12M			12				

Auto Butt Weld Long Elbow

RWL-A

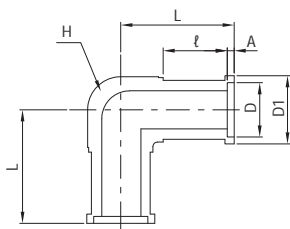

Part No.	D Tube Size	Wall Thickness	ℓ	A	L	D1	H Hex. Body	Working Pressure
Fractional	in.		mm (in.)				in.	psig (barg)
RWL-4A	1/4	0.035	19.0 (0.75)	0.51 (0.02)	31.8 (1.25)	7.4 (0.29)	7/16	5100 (351)
RWL-6A	3/8			0.76 (0.03)	31.2 (1.23)	10.4 (0.41)		3300 (227)
RWL-8A	1/2	0.049	19.0 (0.75)	1.0 (0.04)	35.1 (1.38)	14.0 (0.55)	11/16	3700 (254)
RWL-12A	3/4				38.1 (1.50)	20.3 (0.80)	15/16	2400 (165)
RWL-16A	1	0.065	24.4 (0.96)		48.0 (1.89)	26.9 (1.06)	1 1/4	
Metric	mm		mm (in.)				in.	barg (psig)
RWL-6MA	6	1	19.0 (0.75)	0.51 (0.02)	31.8 (1.25)	6.9 (0.27)	7/16	351 (5100)
RWL-8MA	8			0.76 (0.03)	32.0 (1.26)	8.9 (0.35)		227 (3300)
RWL-10MA	10	1	19.0 (0.75)	1.0 (0.04)	34.8 (1.37)	10.9 (0.43)	11/16	254 (3700)
RWL-12MA	12				35.1 (1.38)	13.2 (0.52)		199 (2888)
RWL-18MA	18	1.5			38.6 (1.52)	19.3 (0.76)	15/16	206 (2989)

Auto Butt Weld Long Tee

RWT-A

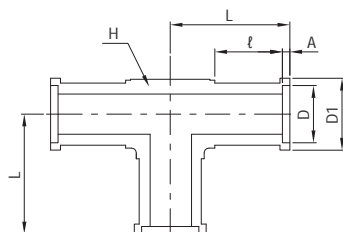

Part No.	D Tube Size	Wall Thickness	ℓ	A	L	D1	H Hex. Body	Working Pressure
Fractional	in.		mm (in.)				in.	psig (barg)
RWT-4A	1/4	0.035	19.0 (0.75)	0.51 (0.02)	31.8 (1.25)	7.4 (0.29)	7/16	5100 (351)
RWT-6A	3/8			0.76 (0.03)	31.2 (1.23)	10.4 (0.41)		3300 (227)
RWT-8A	1/2	0.049	19.0 (0.75)	1.0 (0.04)	35.1 (1.38)	14.0 (0.55)	11/16	3500 (241)
RWT-12A	3/4				38.1 (1.50)	20.3 (0.80)	15/16	2400 (165)
RWT-16A	1	0.065	24.4 (0.96)		48.0 (1.89)	26.9 (1.06)	1 1/4	
Metric	mm		mm (in.)				in.	barg (psig)
RWT-6MA	6	1	19.0 (0.75)	0.51 (0.02)	31.8 (1.25)	6.9 (0.27)	7/16	454 (6589)
RWT-8MA	8			0.76 (0.03)	32.0 (1.26)	8.9 (0.35)		323 (4687)
RWT-10MA	10	1	19.0 (0.75)	1.0 (0.04)	34.8 (1.37)	10.9 (0.43)	11/16	254 (3686)
RWT-12MA	12				35.1 (1.38)	13.2 (0.52)		206 (2989)
RWT-18MA	18	1.5			38.6 (1.52)	19.3 (0.76)	15/16	

Auto Butt Weld Long Cross

RWX-A

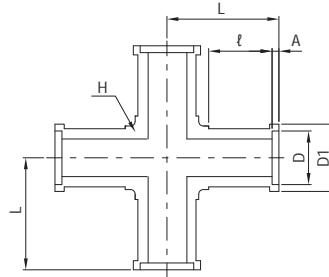

Part No.	D Tube Size	Wall Thickness	ℓ	A	L	D1	H Hex. Body	Working Pressure
Fractional	in.		mm (in.)				in.	psig (barg)
RWX-4A	1/4	0.035	19.0 (0.75)	0.51 (0.02)	31.8 (1.25)	7.4 (0.29)	7/16	5100 (351)
RWX-6A	3/8			0.76 (0.03)	31.2 (1.23)	10.4 (0.41)		3300 (227)
RWX-8A	1/2			0.049	1.0 (0.04)	34.0 (1.34)	14.0 (0.55)	5/8
Metric	mm		mm (in.)				in.	barg (psig)
RWX-6MA	6	1	19.0 (0.75)	0.51 (0.02)	31.8 (1.25)	6.9 (0.27)	7/16	420 (6095)
RWX-8MA	8			0.76 (0.03)		8.9 (0.35)		310 (4499)
RWX-10MA	10			1.0 (0.04)	10.9 (0.43)	5/8	240 (3483)	
RWX-12MA	12			1.0 (0.04)	34.0 (1.34)	13.2 (0.52)	200 (2902)	

Auto Butt Weld Long Reducing Tee

RWT-A

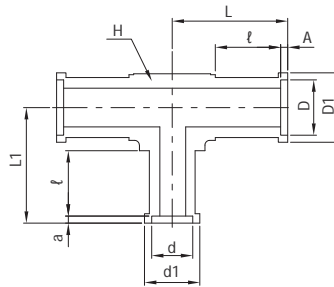

Part No.	D Tube Size	Wall Thickness	d Tube Size	Wall Thickness	ℓ	A	a	L1	L	D1	d1	H Hex. Body	Working Pressure	
Fractional	in.				mm(in.)								in.	psig (barg)
RWT6-4A	3/8	0.035	1/4	0.035	19.0 (0.75)	0.76 (0.03)	0.51 (0.02)	31.8 (1.25)	31.2 (1.23)	10.4 (0.41)	7.4 (0.29)	7/16	3300 (227)	
RWT8-4A	1/2	0.049				1.0 (0.04)		35.1 (1.38)	35.1 (1.38)	14.0 (0.55)			11/16	3700 (254)
RWT8-6A			3/8			0.76 (0.03)	34.8 (1.37)	10.4 (0.41)	3300 (227)					
RWT12-6A	3/4	0.049	1/2			1.0 (0.04)	38.1 (1.50)	38.1 (1.50)	20.3 (0.80)	15/16	2400 (165)			
RWT12-8A				14.0 (0.55)	2400 (165)									
Metric	mm				mm(in.)								in.	barg (psig)
RWT12M-6MA	12	1	6	1	19.0 (0.75)	0.51 (0.02)	0.51 (0.02)	34.5 (1.36)	35.1 (1.38)	13.2 (0.52)	6.9 (0.27)	11/16	200 (2902)	

Auto Butt Weld Union

RWU-A

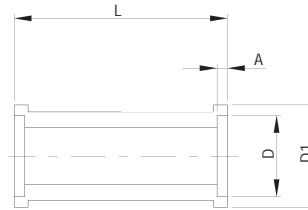

Part No.	D Tube Size	Wall Thickness	A	L	D1	Working Pressure
Fractional	in.		mm (in.)			psig (barg)
RWU-4A	1/4	0.035	0.51 (0.02)	25.4 (1.0)	7.4 (0.29)	5100 (351)
RWU-6A	3/8		0.76 (0.03)		10.4 (0.41)	3300 (227)
RWU-8A	1/2	0.049	1.0 (0.04)		14.0 (0.55)	3700 (254)
RWU-12A	3/4				20.3 (0.80)	2400 (165)
RWU-16A	1	0.065		31.8 (1.25)	26.9 (1.06)	
Metric	mm		mm (in.)			barg (psig)
RWU-6MA	6	1	0.51 (0.02)	31.8 (1.25)	6.9 (0.27)	420 (6095)
RWU-8MA	8		0.76 (0.03)		8.9 (0.35)	310 (4499)
RWU-10MA	10		1.0 (0.04)		10.9 (0.43)	240 (3483)
RWU-12MA	12	13.2 (0.52)			200 (2902)	
RWU-18MA	18	1.5		19.3 (0.76)		

Auto Butt Weld Reducing Union

RWU-A

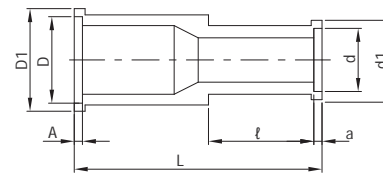

Part No.	D Tube Size	Wall Thickness	d Tube Size	Wall Thickness	L	ℓ	A	a	D1	d1	Working Pressure	
Fractional	in.				mm (in.)							psig (barg)
RWU6-4A	3/8	0.035	1/4	0.035	40.1 (1.58)	19.0 (0.75)	0.76 (0.03)	0.51 (0.02)	10.4 (0.41)	7.4 (0.29)	3300 (227)	
RWU8-4A	1/2		0.049				3/8	1.0 (0.04)	0.76 (0.03)	14.0 (0.55)	10.4 (0.41)	3700 (254)
RWU8-6A		3/4		1.0 (0.04)								20.3 (0.80)
RWU12-8A	3/4		1/2	0.049			41.1 (1.62)		1.0 (0.04)	20.3 (0.80)	14.0 (0.55)	2400 (165)
Metric	mm				mm (in.)							barg (psig)
RWU8M-6MA	8	1	6	1	39.9 (1.57)	19.0 (0.75)	0.76 (0.03)	0.51 (0.02)	8.9 (0.35)	6.9 (0.27)	310 (4499)	
RWU12M-6MA	12				8		40.1 (1.58)	0.04 (1.0)	13.2 (0.52)		8.9 (0.35)	200 (2902)
RWU12M-8MA							40.4 (1.59)			0.76 (0.03)		

Pressure Rating

All pressure rating follow the calculation as to ASME B31.3 Process Piping code and ASME B31.1 Power Piping code.

The working pressure rating at the room temperature is determined by the material of gasket and the allowable temperature range per the materials is listed in Table 2.

Table 2. Temperature range

Part	Material	Temperature °F (°C)
Fitting	SS 316	1000 (537)
	SS 316L	
Gasket	316L	1000 (537)
	Nickel	600 (315)
	Copper	400 (204)

Material

Material	Designation	Specification	
		Bar stock	Forging
Stainless Steel 316	S	ASME SA479 ASTM A479 / A276	ASME SA182 ASTM A182
Stainless Steel 316L	L		
Stainless Steel 316L Single Vacuum Melting	SL		
Stainless Steel 316L Double Vacuum Melting	DL		
Gasket	SS 316L	ASTM SA182 or Equivalent	
	Nickel	ASTM F3 or Equivalent	
	Copper	ASTM B152 or Equivalent	

Cleaning & Packing

Passivation is done in accordance with ASTM A380 and the Ultra-sonic cleaning in clean room (class 100) is implemented with resistivity over 18MΩ D.I water after finishing the passivation for precision cleaning. After Cleaning, the product shall be double packed in the clean room within anti-static polyethylene bags where let high purity nitrogen in.

Surface roughness

Grade	Designation	Roughness, Ra
BA	Nil	10 μin. (0.25μm)

Plating

The internal surface of female-threaded nut are silver plated to reduce the galling and the pull-up torque.

In the case of the damage or removal of the silver plating thread galling may be occur and make some damage on the fitting components to prevent proper sealing performance.

Testing

RCR Fittings meet the below helium leakage limitation per the material of gasket.

- Silver plated stainless steel 316L and copper gasket : the maximum leak rate 4×10^{-9} std cm³/s
- Unplated stainless steel 316L : the maximum leak rate 4×10^{-11} std cm³/s

Feature

- The Leak-tight service provided from vacuum to positive pressure application
- Minimized space is needed for installation or removal

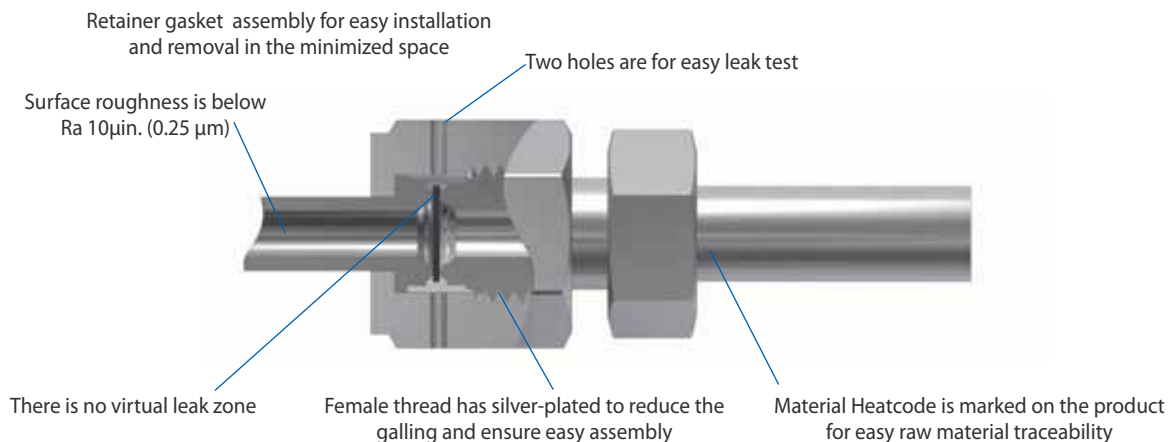

Short Gland

RSG

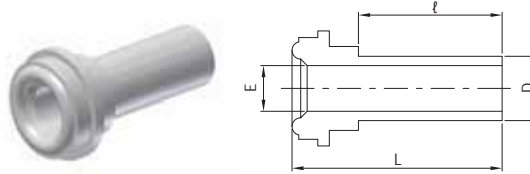

Part No.	Size	D Tube Size	Wall Thickness	L	ℓ	E	Working Pressure			
							NI	S	CU	
Fractional		in.		mm (in.)			psig (barg)			
RSG-2	1/8	1/8	0.028	27.4 (1.08)	19.1 (0.75)	1.5 (0.06)	8500 (585)	8500 (585)	6800 (468)	
RSG4-2	1/4			27.9 (1.1)			5100 (351)	5100 (351)	5100 (351)	
RSG-4-L152	1/4	1/4	0.035	15.2 (0.6)	6.4 (0.25)	4.6 (0.18)	5100 (351)	5100 (351)	5100 (351)	
RSG-4-L183				18.3 (0.72)						9.6 (0.38)
RSG-4-L279				27.9 (1.1)						19.1 (0.75)
RSG8-4	1/2	3/8	0.035	28.4 (1.12)	19.1 (0.75)	7.9 (0.31)	3500 (241)	4300 (296)	2800 (192)	
RSG8-6L157	1/2			15.7 (0.62)			6.4 (0.25)	3300 (227)	3300 (227)	2600 (179)
RSG8-6L284		28.4 (1.12)	19.1 (0.75)							
RSG-8-L157	1/2	1/2	0.049	15.7 (0.62)	6.4 (0.25)	10.2 (0.4)	3500 (241)	3500 (241)	2800 (192)	
RSG-8-L188				18.8 (0.74)						9.6 (0.38)
RSG-8-L284				28.4 (1.12)						19.1 (0.75)
Metric		mm		mm (in.)			barg (psig)			
RSG4-6M	1/4	6	1.0	29.5 (1.16)	19.1 (0.75)	4.0 (0.16)	468 (6800)	468 (6800)	372 (5400)	
RSG4-8M		8				6.0 (0.24)	337 (4900)	337 (4900)	337 (4900)	
RSG8-10M	1/2	10	1.5	31.0 (1.22)	19.1 (0.75)	8.0 (0.31)	241 (3500)	241 (3500)	192 (2800)	
RSG8-12M		12				10.0 (0.39)	213 (3100)	213 (3100)	165 (2400)	
RSG12-18M	3/4	18	1.5	31.0 (1.22)	19.1 (0.75)	15.0 (0.59)	206 (3000)	206 (3000)	165 (2400)	

Mini Short Gland

RMSG

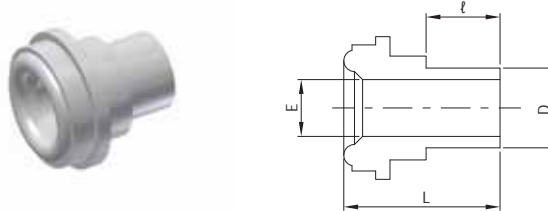

Part No.	R Size (in.)	D Tube Size	Wall Thickness	L	ℓ	E	Working Pressure		
							NI	S	CU
Fractional		in.		mm (in.)			psig (barg)		
RMSG-4	1/4	1/4	0.035	15.2 (0.60)	6.4 (0.25)	4.6 (0.18)	5100 (351)	5100 (351)	5100 (351)
RMSG-6	3/8	3/8		15.7 (0.62)		7.9 (0.31)	3300 (227)	3300 (227)	2600 (179)
RMSG-8	1/2	1/2	0.049	15.8 (0.62)	6.4 (0.25)	10.2 (0.40)	3500 (241)	3500 (241)	2800 (192)
RMSG-6M	1/4	6	1			15.2 (0.60)	4.0 (0.16)	468 (6800)	468 (6800)
RMSG-8M		8		6.0 (0.24)	337 (4900)	337 (4900)	337 (4900)		
RMSG-10M	1/2	10	1	15.8 (0.62)	8.0 (0.31)	241 (3500)	241 (3500)	192 (2800)	
RMSG-12M		12		10.0 (0.39)	213 (3100)	213 (3100)	165 (2400)		

Long Gland

RLG

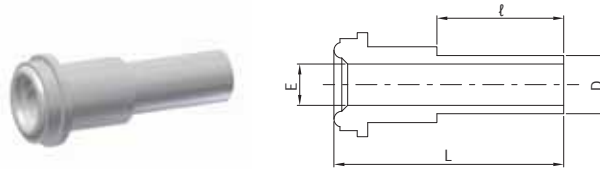

Part No.	R Size	D Tube Size	Wall Thickness	L	ℓ	E	Working Pressure		
							NI	S	CU
Fractional		in.		mm (in.)			psig (barg)		
RLG-2	1/8	1/8	0.028	36.1 (1.42)	19.1 (0.75)	1.5 (0.06)	8500 (585)	8500 (585)	6800 (468)
RLG-4-L305	1/4	1/4	0.035	30.5 (1.2)	6.4 (0.25)	4.6 (0.18)	5100 (351)	5100 (351)	5100 (351)
RLG-4-L333				33.3 (1.31)	9.1 (0.36)				
RLG-4-L335				33.5 (1.32)	9.6 (0.38)				
RLG-4-L432				43.2 (1.7)	19.1 (0.75)				
RLG8-4	1/2	3/8	0.035	45.7 (1.8)	19.1 (0.75)	7.9 (0.31)	3500 (241)	4300 (296)	2800 (192)
RLG8-6L328	1/2			32.8 (1.29)	6.4 (0.25)	7.9 (0.31)	3300 (227)	3300 (227)	2600 (179)
RLG8-6L455	1/2	1/2	0.049	45.5 (1.79)	19.1 (0.75)	10.2 (0.4)	3500 (241)	3500 (241)	2800 (192)
RLG-8-L328				32.8 (1.29)	6.4 (0.25)				
RLG-8-L358				35.8 (1.41)	9.6 (0.38)				
RLG-8-L455	3/4	3/4	0.065	45.5 (1.79)	19.1 (0.75)	16.5 (0.65)	2400 (165)	2400 (165)	1900 (130)
RLG-12				51.6 (2.03)					
RLG-16	1	1	0.065	58.9 (2.32)	19.1 (0.75)	22.1 (0.87)	2400 (165)	2400 (165)	1900 (130)
Metric		mm		mm (in.)			barg (psig)		
RLG4-6M	1/4	6	1.0	43.2 (1.7)	19.1 (0.75)	4.0 (0.16)	468 (6800)	468 (6800)	372 (5400)
RLG4-8M		8				6.0 (0.24)	337 (4900)	337 (4900)	337 (4900)
RLG8-10M	1/2	10	1.0	45.5 (1.79)	19.1 (0.75)	8.0 (0.31)	241 (3500)	241 (3500)	192 (2800)
RLG8-12M		12				10.0 (0.39)	213 (3100)	213 (3100)	165 (2400)
RLG12-18M	3/4	18	1.5	51.6 (2.03)	19.1 (0.75)	15.0 (0.59)	206 (3000)	206 (3000)	165 (2400)

Mini Long Gland

RMLG

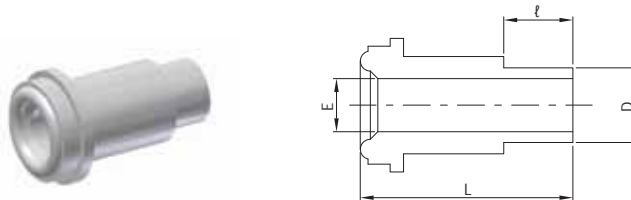

Part No.	R Size (in.)	D Tube Size	Wall Thickness	L	ℓ	E	Working Pressure		
							NI	S	CU
Fractional		in.		mm (in.)			psig (barg)		
RMLG-4	1/4	1/4	0.035	30.5 (1.20)	6.4 (0.25)	4.6 (0.18)	5100 (351)	5100 (351)	5100 (351)
RMLG-6	1/2	3/8		32.8 (1.29)		7.9 (0.31)	3300 (227)	3300 (227)	2600 (179)
RMLG-8		1/2	1/2	0.049	45.5 (1.79)	19.1 (0.75)	10.2 (0.40)	3500 (241)	3500 (241)
Metric		mm		mm (in.)			barg (psig)		
RMLG-6M	1/4	6	1	31.0 (1.22)	6.4 (0.25)	4.0 (0.16)	468 (6800)	468 (6800)	372 (5400)
RMLG-8M		8		31.2 (1.23)		6.0 (0.24)	337 (4900)	337 (4900)	337 (4900)
RMLG-10M	1/2	10	1	32.8 (1.29)	6.4 (0.25)	8.0 (0.31)	241 (3500)	241 (3500)	192 (2800)
RMLG-12M		12		33.8 (1.33)		10.0 (0.39)	213 (3100)	213 (3100)	165 (2400)

Auto Butt Weld Short Gland

RSG-A

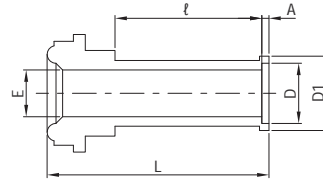

Part No.	R Size (in.)	D Tube Size	Wall Thickness	L	ℓ	A	E	D1	Working Pressure		
									NI	S	CU
Fractional		in.		mm (in.)					psig (barg)		
RSG-4A	1/4	1/4	0.035	28.4 (1.12)	19.1 (0.75)	0.5 (0.02)	4.6 (0.18)	7.4 (0.29)	5100 (351)	5100 (351)	5100 (351)
RSG-6A	1/2	3/8		29.2 (1.15)		0.8 (0.03)	7.9 (0.31)	10.4 (0.41)	3300 (227)	3300 (227)	2600 (179)
RSG-8A		1/2	0.049	29.5 (1.16)		1.0 (0.04)	10.2 (0.40)	14.0 (0.55)	3500 (241)	3500 (241)	2800 (192)
Metric		mm		mm (in.)					barg (psig)		
RSG-6MA	1/4	6	1	30.0 (1.18)	19.1 (0.75)	0.5 (0.02)	4.0 (0.16)	6.8 (0.27)	468 (6800)	468 (6800)	372 (5400)
RSG-8MA		8		30.2 (1.19)		0.8 (0.03)	6.0 (0.24)	8.9 (0.35)	337 (4900)	337 (4900)	337 (4900)
RSG-10MA	1/2	10		31.0 (1.22)		0.8 (0.03)	8.0 (0.31)	10.9 (0.43)	241 (3500)	241 (3500)	192 (2800)
RSG-12MA		12	30.5 (1.20)	1.0 (0.04)	10.0 (0.39)	13.2 (0.52)	213 (3100)	213 (3100)	165 (2400)		

Auto Butt Weld Long Gland

RLG-A

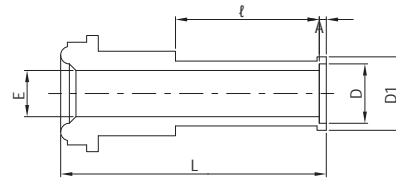

Part No.	R Size (in.)	D Tube Size	Wall Thickness	L	ℓ	A	E	D1	Working Pressure		
									NI	S	CU
Fractional		in.		mm (in.)					psig (barg)		
RLG-4A	1/4	1/4	0.035	1.72 (43.7)	19.1 (0.75)	0.5 (0.02)	4.6 (0.18)	7.4 (0.29)	5100 (351)	5100 (351)	5100 (351)
RLG-4A				1.82 (46.2)					3500 (241)	3500 (241)	2800 (192)
RLG-6A	1/2	3/8	0.049	1.83 (46.5)		0.8 (0.03)	7.9 (0.31)	10.4 (0.41)	3300 (227)	3300 (227)	2600 (179)
RLG-8A		1/2		1.83 (46.5)	10.2 (0.40)	14.0 (0.55)	3500 (241)	3500 (241)	2800 (192)		
RLG-12A	3/4	3/4	2.07 (52.6)	1.0 (0.04)	16.5 (0.65)	20.3 (0.80)	2400 (165)	2400 (165)	2400 (165)		
RLG-16A	1	1	0.065	2.57 (65.3)	24.4 (0.96)	22.1 (0.87)	26.9 (1.06)	2400 (165)	2400 (165)	1900 (130)	
Metric		mm		mm (in.)					barg (psig)		
RLG-6MA	1/4	6	1	43.7 (1.72)	19.1 (0.75)	0.5 (0.02)	4.0 (0.16)	6.8 (0.27)	468 (6800)	468 (6800)	372 (5400)
RLG-8MA		8		43.9 (1.73)					0.8 (0.03)	6.0 (0.24)	8.9 (0.35)
RLG-10MA	1/2	10		46.5 (1.83)		0.8 (0.03)	8.0 (0.31)	10.9 (0.43)	241 (3500)	241 (3500)	192 (2800)
RLG-12MA		12	46.5 (1.83)	1.0 (0.04)	10.0 (0.39)	13.2 (0.52)	213 (3100)	213 (3100)	165 (2400)		
RLG-18MA	3/4	18	1.5	2.07 (52.6)	1.0 (0.04)	15.0 (0.59)	0.76 (19.3)	206 (3000)		206 (3000)	

Male Gland

RGM

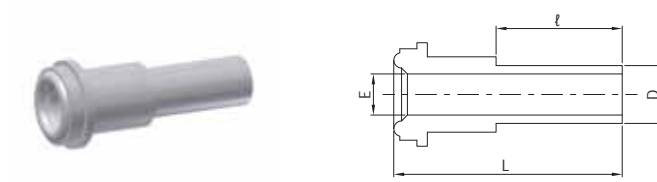

Part No.	R Size (in.)	D Tube Size	L	ℓ	E	Working Pressure		
						NI	S	CU
Fractional		in.	mm (in.)			psig (barg)		
RGM-2	1/8	1/8	17.8 (0.70)	7.1 (0.28)	1.5 (0.06)	9000 (620)	11200 (771)	7200 (496)
RGM4-2	1/4		33.3 (1.31)			8000 (551)	10000 (689)	6400 (440)
RGM-4		1/2	1/4	38.1 (1.50)	10.4 (0.41)	3.0 (0.12)	3500 (241)	4300 (296)
RGM8-4	7.1 (0.28)							
RGM-6	1/2	3/8	38.1 (1.50)	12.7 (0.50)	0.4 (10.2)	3500 (241)	3500 (241)	3500 (241)
RGM-8		1/2						
RGM-12	3/4	3/4	50.8 (2.00)	15.7 (0.62)	0.53 (13.5)	3000 (206)	3700 (254)	2400 (165)
RGM-16	1	1	56.4 (2.22)	20.6 (0.81)	0.75 (19.1)	2400 (165)	3000 (206)	1900 (130)

Auto Butt Weld Mini Short Gland

RMSG-A

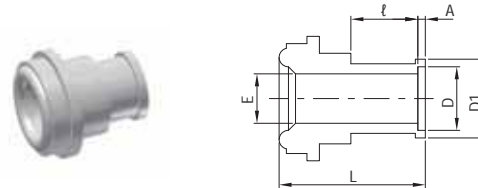

Part No.	R Size (in.)	D Tube Size	Wall Thickness	L	ℓ	A	E	D1	Working Pressure		
									NI	S	CU
Fractional		in.	mm (in.)						psig (barg)		
RMSG-4A	1/4	1/4	0.035	15.7 (0.62)	6.35 (0.25)	0.5 (0.02)	4.6 (0.18)	7.4 (0.29)	5100 (351)	5100 (351)	5100 (351)
RMSG-6A	1/2	3/8		16.6 (0.65)			7.9 (0.31)	10.4 (0.41)	3300 (227)	3300 (227)	2600 (179)
RMSG-8A		1/2	0.049	16.8 (0.66)			10.2 (0.40)	14.0 (0.55)	3500 (241)	3500 (241)	2800 (192)
Metric		mm	mm (in.)						barg (psig)		
RMSG-6MA	1/4	4	1	15.7 (0.62)	6.35 (0.25)	0.5 (0.02)	4.0 (0.16)	6.8 (0.27)	468 (6800)	468 (6800)	372 (5400)
RMSG-8MA		6	1	16.6 (0.65)			6.0 (0.24)	8.9 (0.35)	337 (4900)	337 (4900)	337 (4900)
RMSG-10MA	1/2	10	1	16.6 (0.65)			0.8 (0.03)	8.0 (0.31)	10.9 (0.43)	241 (3500)	241 (3500)
RMSG-12MA		12	1	16.8 (0.66)	1.0 (0.04)	10.0 (0.39)	13.2 (0.52)	213 (3100)	213 (3100)	165 (2400)	

Socket Gland

RGS

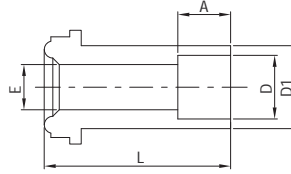

Part No.	R Size (in.)	D Tube Size	L	A	E	D1	Working Pressure		
							NI	S	CU
Fractional		in.	mm (in.)				psig (barg)		
RGS2-1S	1/8	1/16	17.8 (0.70)	2.5 (0.10)	1.3 (0.05)	3.3 (0.13)	9000 (620)	9000 (620)	7200 (496)
RGS-2S		1/8			2.3 (0.09)	5.1 (0.20)	7100 (489)	7100 (489)	7100 (489)
RGS-4S	1/4	1/4	33.3 (1.31)	7.1 (0.28)	4.6 (0.18)	8.9 (0.35)	5500 (378)	5500 (378)	5500 (378)
RGS-6S	1/2	3/8	38.1 (1.50)	7.9 (0.31)	7.1 (0.28)	15.2 (0.60)	3500 (241)	4300 (296)	2800 (192)
RGS-8S		1/2					9.6 (0.38)	10.2 (0.40)	3000 (206)
RGS-10S	5/8	5/8	39.6 (1.56)	10.4 (0.41)	12.7 (0.50)	18.3 (0.72)	2800 (192)	2800 (192)	2200 (151)
RGS-12S	3/4	3/4	50.8 (2.00)	11.2 (0.44)	15.7 (0.62)	22.4 (0.88)			
RGS-16S	1	1	56.4 (2.22)	15.7 (0.62)	22.1 (0.87)	30.2 (1.19)	2400 (165)	3000 (206)	1900 (130)

Reducing Socket Gland

RGS

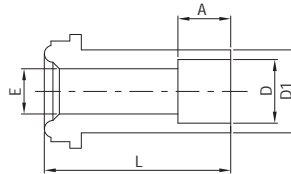

Part No.	R Size (in.)	D Tube Size	L	A	E	D1	Working Pressure		
							NI	S	CU
Fractional		in.	mm (in.)				psig (barg)		
RGS4-2S	1/4	1/8	33.3 (1.31)	2.5 (0.10)	2.3 (0.09)	8.9 (0.35)	8000 (551)	8000 (551)	8000 (551)
RGS8-4S	1/2	1/4	38.1 (1.50)	7.1 (0.28)	4.6 (0.18)	15.2 (0.60)	3500 (241)	3500 (241)	3500 (241)

Short Socket Gland

RGS

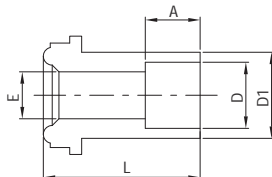

Part No.	R Size (in.)	D Tube Size	L	A	E	D1	Working Pressure		
							NI	S	CU
Fractional		in.	mm (in.)				psig (barg)		
RGS-4SL12.7	1/4	1/4	12.7 (0.5)	7.1 (0.28)	4.6 (0.18)	8.9 (0.35)	5500 (378)	5500 (378)	5500 (378)
RGS-4SL19.1			19.1 (0.75)						

Tube Adapter Gland

RGT

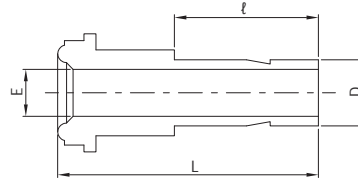

Part No.	R Size (in.)	D Tube Size	L	ℓ	E	Working Pressure		
						NI	S	CU
Fractional		in.	mm (in.)			psig (barg)		
RGT-4	1/4	1/4	41.0 (1.62)	16.2 (0.64)	4.3 (0.17)	8000 (551)	10000 (689)	6400 (440)
RGT-6	1/2	3/8	46.0 (1.81)	17.8 (0.70)	6.8 (0.27)	3500 (241)	4300 (296)	2800 (192)
RGT-8		1/2	49.3 (1.94)	24.4 (0.96)	9.4 (0.37)			

Blind Gland

RBG

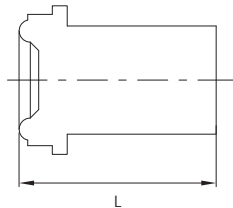

Part No.	R Size (in.)	L
		mm (in.)
RBG-2	1/8	17.8 (0.7)
RBG-4	1/4	33.3 (1.31)
RBG-8	1/2	38.1 (1.50)
RBG-12	3/4	50.8 (2.00)
RBG-16	1	56.4 (2.22)

Coupling

RC

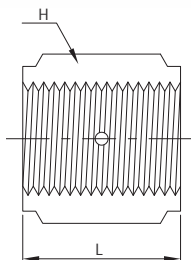

Part No.	R Size (in.)	L	H Hex.
		mm (in.)	in.
RC-2	1/8	16.8 (0.66)	7/16
RC-4	1/4	30.2 (1.19)	3/4
RC-8	1/2	33.3 (1.31)	1 1/16
RC-12	3/4	42.7 (1.68)	1 1/2
RC-16	1	51.8 (2.04)	1 3/4

Union RU

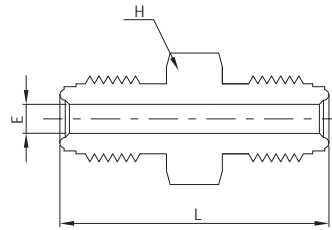

Part No.	R Size (in.)	L	E	H, Hex	Working Pressure psig (barg)		
					mm (in.)		
RU-2	1/8	28.7 (1.13)	2.3 (0.09)	3/8	9000 (620)	11200 (771)	7200 (496)
RU-4	1/4	39.4 (1.55)	4.6 (0.18)	5/8	8000 (551)	10000 (689)	6400 (440)
RU-8	1/2	46.7 (1.84)	10.2 (0.40)	15/16	3500 (241)	4300 (296)	2800 (192)
RU-12	3/4	62.0 (2.44)	15.7 (0.62)	1 5/16	3000 (206)	3700 (254)	2400 (165)
RU-16	1	65.8 (2.59)	22.1 (0.87)	1 5/8	2400 (165)	3000 (206)	1900 (130)

Union Elbow RL

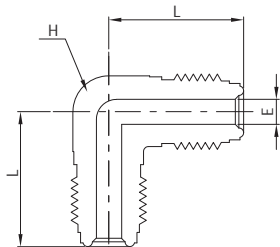

Part No.	R Size (in.)	L	E	H, Hex.	Working Pressure psig (barg)		
					mm (in.)		
RL-2	1/8	22.6 (0.89)	2.3 (0.09)	7/16	9000 (620)	11200 (771)	7200 (496)
RL-4	1/4	27.2 (1.07)	4.6 (0.18)	1/2	8000 (551)	10000 (689)	6400 (440)
RL-8	1/2	36.8 (1.45)	10.2 (0.40)	13/16	3500 (241)	4300 (296)	2800 (192)
RL-12	3/4	48.8 (1.92)	15.7 (0.62)	1 1/4	3000 (206)	3700 (254)	2400 (165)
RL-16	1	50.8 (2.00)	22.1 (0.87)	1 11/16	2400 (165)	3000 (206)	1900 (130)

Union Tee RT

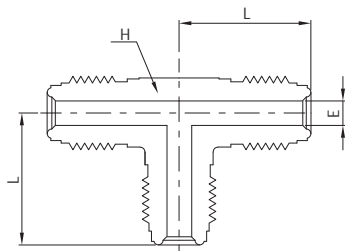

Part No.	R Size (in.)	L	E	H, Hex.	Working Pressure psig (barg)		
					mm (in.)		
RT-2	1/8	22.6 (0.89)	2.3 (0.09)	7/16	9000 (620)	11200 (771)	7200 (496)
RT-4	1/4	27.2 (1.07)	4.6 (0.18)	1/2	8000 (551)	10000 (689)	6400 (440)
RT-8	1/2	36.8 (1.45)	10.2 (0.40)	13/16	3500 (241)	4300 (296)	2800 (192)
RT-12	3/4	48.8 (1.92)	15.7 (0.62)	1 1/4	3000 (206)	3700 (254)	2400 (165)
RT-16	1	50.8 (2.00)	22.1 (0.87)	1 11/16	2400 (165)	3000 (206)	1900 (130)

Union Cross

RX

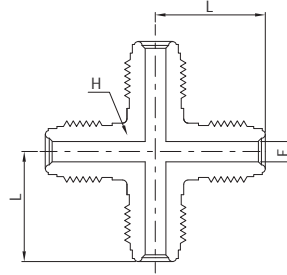

Part No.	R Size (in.)	L		E	H, Hex.	Working Pressure psig (barg)		
		mm (in.)			in.	NI	S	CU
RX-2	1/8	22.6 (0.89)	2.3 (0.09)	7/16	9000 (620)	11200 (771)	7200 (496)	
RX-4	1/4	27.2 (1.07)	4.6 (0.18)	1/2	8000 (551)	10000 (689)	6400 (440)	
RX-8	1/2	36.8 (1.45)	10.2 (0.40)	13/16	3500 (241)	4300 (296)	2800 (192)	
RX-12	3/4	48.8 (1.92)	15.7 (0.62)	1 1/4	3000 (206)	3700 (254)	2400 (165)	
RX-16	1	50.8 (2.00)	22.1 (0.87)	1 11/16	2400 (165)	3000 (206)	1900 (130)	

Reducing Union

RUR

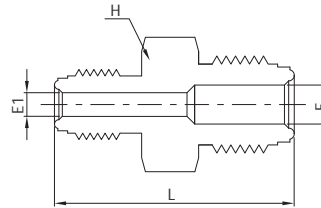

Part No.	R Size (in.)		L	E	E1	H, Hex.	Working Pressure psig (barg)		
			mm (in.)			in.	NI	S	CU
RUR4-2	1/4	1/8	34.8 (1.37)	4.6 (0.18)	2.3 (0.09)	5/8	8000 (551)	10000 (689)	6400 (440)
RUR8-4	1/2	1/4	43.4 (1.71)	10.2 (0.40)	4.6 (0.18)	15/16	3500 (241)	4300 (296)	2800 (192)

Bulkhead Union

RUB

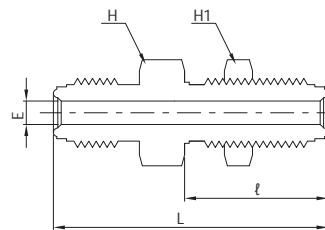

Part No.	R Size (in.)	L	ℓ	E	H, Hex.	H1, Hex.	Panel Hole Size	Max. Panel Thickness	Working Pressure psig (barg)		
		mm (in.)			in.	in.	in. (mm)		NI	S	CU
RUB-4	1/4	56.6 (2.23)	33.0 (1.30)	4.6 (0.18)	3/4	3/4	19/32 (15.0)	0.44 (11.2)	8000 (551)	10000 (689)	6400 (440)
RUB-4L46		46.2 (1.82)	25.1 (0.99)					0.13 (3.3)			
RUB-8	1/2	65.3 (2.57)	37.6 (1.48)	10.2 (0.40)	1 1/16	1 1/16	29/32 (23.1)	0.50 (12.7)	3500 (241)	4300 (296)	2800 (192)
RUB-8L54		54.4 (2.14)	28.2 (1.11)					0.13 (3.3)			

Tube Fitting Connector

RDC

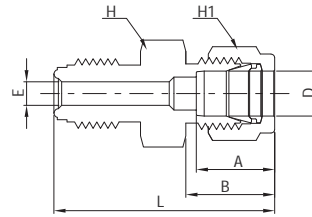

Part No.	R Size (in.)	D Tube Size	L	B	A	E	H, Hex.	H1, Hex.	Working Pressure psig (barg)		
									mm (in.)		
RDC4-2	1/4	1/8	38.9 (1.53)	15.2 (0.60)	12.7 (0.50)	2.3 (0.09)	5/8	7/16	8000 (551)	10000 (689)	6400 (440)
RDC4-4		1/4	41.1 (1.62)	17.8 (0.70)	15.2 (0.60)	4.6 (0.18)		9/16			
RDC8-6	1/2	3/8	46.7 (1.84)	19.3 (0.76)	16.8 (0.66)	7.1 (0.28)	15/16	11/16	3500 (241)	4300 (296)	2800 (192)
RDC8-8		1/2	49.5 (1.95)	21.8 (0.86)	22.9 (0.90)	10.2 (0.40)		7/8			

Tube Fitting Bulkhead Connector

RDCB

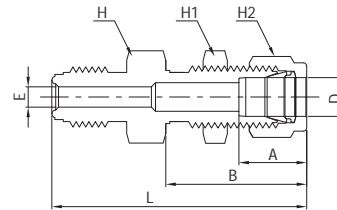

Part No.	R Size (in.)	D Tube Size	L	B	A	E	H, Hex.	H1, Hex.	H2, Hex.	Panel Hole Size	Max. Panel Thickness	Working Pressure psig (barg)		
												mm (in.)		
RDCB4-4	1/4	1/4	57.2 (2.25)	33.5 (1.32)	15.2 (0.60)	4.6 (0.18)	5/8	5/8	9/16	15/32 (11.9)	10.2 (0.4)	8000 (551)	10000 (689)	6400 (440)
RDCB4-4L48			47.8 (1.88)	26.7 (1.05)							3.3 (0.13)			
RDCB8-6	1/2	3/8	64.5 (2.54)	36.8 (1.45)	16.8 (0.66)	7.1 (0.28)	15/16	3/4	11/16	19/32 (15.0)	11.2 (0.44)	3500 (241)	4300 (296)	2800 (192)
RDCB8-8		1/2	69.6 (2.74)	41.9 (1.65)	22.9 (0.90)	10.2 (0.40)		15/16	7/8	25/32 (19.8)	12.7 (0.5)			

Male NPT Connector

RMC-N

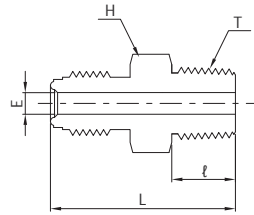

Part No.	R Size (in.)	NPT T	L	ℓ	E	H, Hex.	Working Pressure psig (barg)		
							mm (in.)		
RMC2-1N	1/8	1/16	27.2 (1.07)	9.6 (0.38)	2.3 (0.09)	3/8	9000 (620)	9000 (620)	7200 (496)
RMC2-2N		1/8				7/16			
RMC4-2N	1/4	1/4	33.3 (1.31)	14.2 (0.56)	4.6 (0.18)	5/8	8000 (551)	10000 (689)	6400 (440)
RMC4-4N			37.8 (1.49)						
RMC8-4N	1/2	3/8	41.9 (1.65)	19.1 (0.75)	7.1 (0.28)	15/16	3500 (241)	4300 (296)	2800 (192)
RMC8-6N			9.6 (0.38)						
RMC8-8N			10.2 (0.40)						
RMC12-12N	3/4	3/4	55.6 (2.19)	15.7 (0.62)	15/16	3000 (206)	3700 (254)	2400 (165)	
RMC16-16N	1	1	62.7 (2.47)	23.9 (0.94)	22.1 (0.87)	1 5/8	2400 (165)	3000 (206)	1900 (130)

Male NPT Elbow

RLM-N

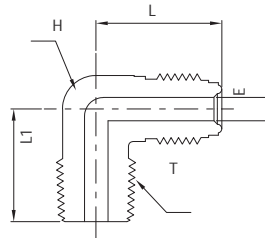

Part No.	R Size (in.)	NPT T	L	L1	ℓ	E	H, Hex.	Working Pressure psig (barg)		
								mm (in.)		
RLM4-2N	1/4	1/8	1.07 (27.2)	22.1 (0.87)	9.6 (0.38)	4.6 (0.18)	1/2	8000 (551)	10000 (689)	6400 (440)
RLM4-4N		1/4		26.7 (1.05)						
RLM8-6N	1/2	3/8	1.45 (36.8)	32.0 (1.26)	19.1 (0.75)	10.2 (0.40)	13/16	3500 (241)	4300 (296)	2800 (192)
RLM8-8N		1/2		36.8 (1.45)						

Straight thread O-Ring Seal Male Connector

RMC-UO

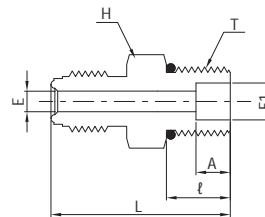

Part No.	R Size (in.)	T Straight Thread Size	L	ℓ	A	E1	E	H, Hex.	Standard O-Ring Size	Working Pressure psig (barg)		
										mm (in.)		
RMC4-6U	1/4	9/16-18	33.8 (1.33)	9.9 (0.39)	6.4 (0.25)	4.6 (0.18)	7.1 (0.28)	3/4	906	4500 (310)	4500 (310)	4500 (310)
RMC8-6U			37.6 (1.48)	9.9 (0.39)	-	7.1 (0.28)	7.1 (0.28)	15/16				
RMC8-10U	1/2	7/8-14	42.2 (1.66)	12.7 (0.50)	10.2 (0.40)	7.1 (0.28)	15.0 (0.59)	1	910	3500 (241)	3500 (241)	2800 (192)

Female NPT Connector

RCF-N

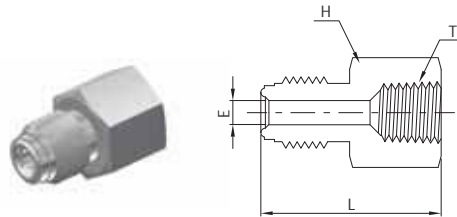

Part No.	R Size (in.)	NPT T	L	E	H, Hex.	Working Pressure psig (barg)		
						mm (in.)		
RCF2-1N	1/8	1/16	27.9 (1.10)	2.3 (0.09)	7/16	6700 (461)	6700 (461)	6700 (461)
RCF2-2N		1/8	30.2 (1.19)		9/16	6500 (447)	6500 (447)	6500 (447)
RCF4-2N	1/4	1/4	35.8 (1.41)	4.6 (0.18)	5/8	8000 (551)	8000 (551)	6400 (440)
RCF4-4N			3/4		6600 (454)	6600 (454)	5200 (358)	
RCF8-6N	1/2	3/8	44.7 (1.76)	10.2 (0.40)	15/16	3500 (241)	4300 (296)	2800 (192)
RCF8-8N		1/2	50.5 (1.99)		1 1/16			
RCF12-12N	3/4	3/4	59.9 (2.36)	15.7 (0.62)	1 5/16	3000 (206)	3700 (254)	2400 (165)
RCF16-16N	1	1	63.8 (2.51)	22.1 (0.87)	1 5/8	2400 (165)	3000 (206)	1900 (130)

Bulkhead Male NPT Connector

RMCB-N

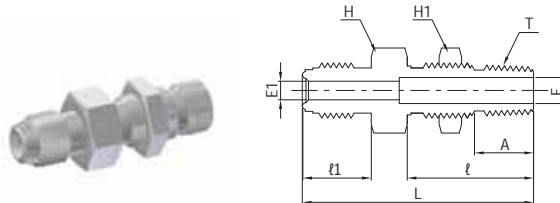

Part No.	R Size (in.)	NPT T	L	l1	A	E	E1	l	H, Hex.	H1, Hex.	Panel Hole Size	Max. Panel Thickness	Working Pressure psig (barg)		
													mm (in.)		
RMCB4-4N	1/4	1/4	56.1 (2.21)	15.7 (0.62)	14.2 (0.56)	4.6 (0.18)	7.1 (0.28)	31.5 (1.24)	13/16	13/16	21/32 (16.8)	0.38 (9.7)	8000 (551)	8000 (551)	6400 (440)
RMCB8-4N	1/2		59.4 (2.34)	19.1 (0.75)		10.2 (0.40)			15/16				3500 (241)	4370 (301)	2800 (192)

Tube Butt Weld Bulkhead Connector

RBT

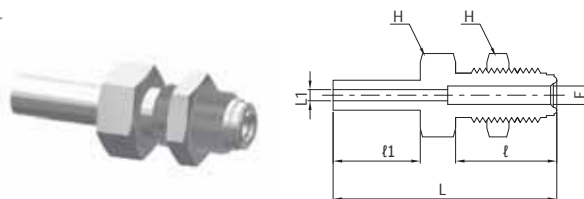

Part No.	R Size (in.)	D Tube Size	L	l1	l	E1	E	H, Hex.	Panel Hole Size	Max. Panel Thickness	Working Pressure psig (barg)		
											mm (in.)		
RBT4-4L	1/4	1/4	59.9 (2.36)	19.1 (0.75)	33.0 (1.30)	4.6 (0.18)	5.6 (0.22)	3/4	19/32 (15.0)	0.44 (11.2)	5100 (351)	5100 (351)	5100 (351)
RBT4-4L50			49.5 (1.95)		25.1 (0.99)								

Swivel Female / Male Union

RSMU

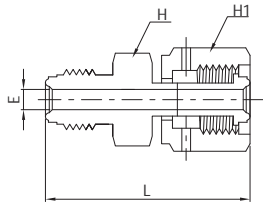

Part No.	R Size (in.)	L	E	H, Hex.	H1, Hex.	Working Pressure psig (barg)		
		mm (in.)		in.		NI	S	CU
RSMU-4	1/4	42.9 (1.69)	4.55 (0.18)	5/8	3/4	8000 (551)	10000 (689)	6400 (440)

Swivel Female Union

RSU

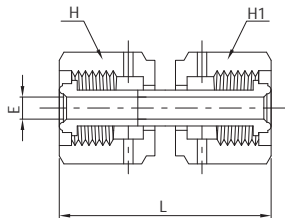

Part No.	R Size (in.)	L	E	H, Hex.	Working Pressure psig (barg)		
		mm (in.)		in.	NI	S	CU
RSU-4	1/4	43.4 (1.71)	4.6 (0.18)	3/4	8000 (551)	10000 (689)	6400 (440)
RSU-8	1/2	46.7 (1.84)	10.2 (0.4)	1 1/16	3500 (241)	4300 (296)	2800 (192)

Swivel Male NPT Connector

RSMC

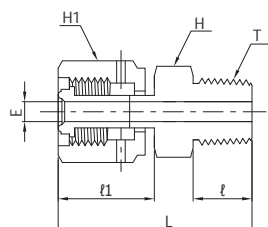

Part No.	R Size (in.)	NPT T	L			E	H, Hex.	H1, Hex.	Working Pressure psig (barg)		
			mm (in.)	ℓ	ℓ1				in.	NI	S
RSMC 4-2N	1/4	1/8	1.58 (40.1)	9.6 (0.38)	24.1 (0.95)	4.6 (0.18)	7/16	3/4	8000 (551)	8000 (551)	6400 (440)
RSMC 4-4N		1/4	1.79 (45.5)	14.2 (0.56)	23.4 (0.92)						
RSMC 8-6N	1/2	3/8	1.89 (48.0)	19.1 (0.75)	25.4 (1.00)	10.2 (0.40)	11/16	1 1/16	3500 (241)	4300 (296)	2800 (192)
RSMC 8-8N		1/2	2.09 (53.1)		25.6 (1.01)		7/8				

Swivel Female NPT Connector

RSCF

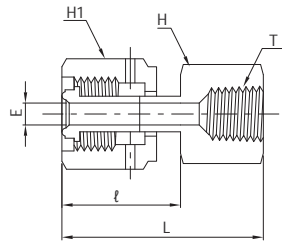

Part No.	R Size (in.)	NPT T	L	ℓ	E	H, Hex.	H, Hex.	Working Pressure psig (barg)		
			mm (in.)			in.		NI	S	CU
RSCF4-4N	1/4	1/4	45.0 (1.77)	23.4 (0.92)	4.6 (0.18)	3/4	3/4	6600 (454)	6600 (454)	5200 (358)
RSCF8-6N	1/2	3/8	49.5 (1.95)	26.9 (1.06)	10.2 (0.40)	7/8	1 1/16	3500 (241)	4300 (296)	2800 (192)
RSCF8-8N		1/2	55.4 (2.18)	26.4 (1.04)		1 1/16				

Swivel Tube Fitting Connector

RSD

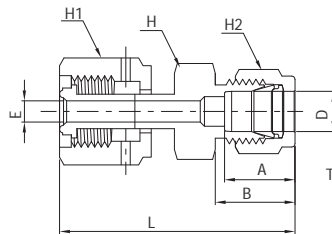

Part No.	R Size (in.)	D Tube Size	E	L	A	B	H, Hex.	H1, Hex.	H2, Hex.	Working Pressure psig (barg)				
			mm (in.)						in.			NI	S	CU
RSD-4	1/4	1/4	4.6 (0.18)	49.3 (1.94)	15.2 (0.6)	17.8 (0.7)	1/2	3/4	9/16	8000 (551)	10000 (689)	6400 (440)		

Swivel Elbow

RSL

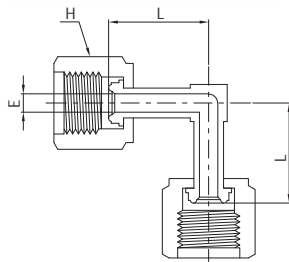

Part No.	R Size (in.)	L	E	H, Hex.	Working Pressure psig (barg)		
		mm (in.)		in.	NI	S	CU
RSL-4	1/4	25.4 (1.00)	4.6 (0.18)	3/4	5100 (351)	5100 (351)	5100 (351)

Swivel Tee

RST

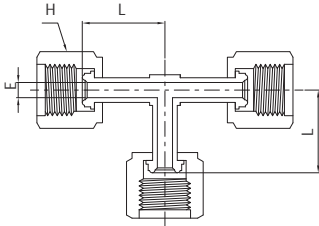

Part No.	R Size (in.)	L	E	H, Hex.	Working Pressure psig (barg)		
		mm (in.)		in.	NI	S	CU
RST-4	1/4	25.4 (1.00)	4.6 (0.18)	3/4	5100 (351)	5100 (351)	5100 (351)

Female Nut

RFN

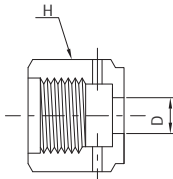

Part No.	R Size (in.)	L	D	H, Hex.
		mm (in.)		in.
RFN-2	1/8	13.5 (0.53)	5.3 (0.21)	7/16
RFN-4	1/4	20.6 (0.81)	9.1 (0.36)	3/4
RFN-8	1/2	22.4 (0.88)	15.5 (0.61)	1 1/16
RFN-10	5/8		18.8 (0.74)	1 3/16
RFN-12	3/4	28.4 (1.12)	22.6 (0.89)	1 1/2
RFN-16	1	34.0 (1.34)	30.5 (1.20)	1 3/4

Male Nut

RMN

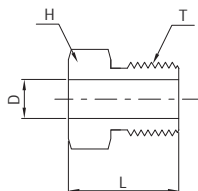

Part No.	R Size (in.)	L	D	H, Hex.
		mm (in.)		in.
RMN-2	1/8	12.7 (0.50)	5.3 (0.21)	3/8
RMN-4	1/4	18.0 (0.71)	9.1 (0.36)	5/8
RMN-8	1/2	20.6 (0.81)	15.5 (0.61)	15/16
RMN-10	5/8		18.8 (0.74)	1 1/16
RMN-12	3/4	25.4 (1.00)	22.6 (0.89)	1 5/16
RMN-16	1	30.2 (1.19)	30.5 (1.20)	1 5/8

Plug RP

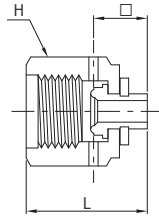

Part No.	R Size (in.)	A (L)	ℓ	H, Hex.
		mm (in.)		in.
RP-2	1/8	16.0 (0.63)	7.6 (0.30)	7/16
RP-4	1/4	23.9 (0.94)	11.2 (0.44)	3/4
RP-8	1/2	25.6 (1.01)	11.4 (0.45)	1 1/16
RP-12	3/4	32.8 (1.29)	13.7 (0.54)	1 1/2
RP-16	1	39.1 (1.54)	16.0 (0.63)	1 3/4

Cap RC

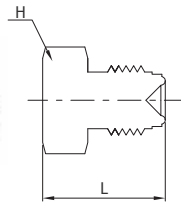

Part No.	R Size (in.)	L	H, Hex.
		mm (in.)	in.
RC-2	1/8	17.3 (0.68)	3/8
RC-4	1/4	23.4 (0.92)	5/8
RC-8	1/2	27.4 (1.08)	15/16
RC-12	3/4	36.3 (1.43)	1 5/16
RC-16	1	38.6 (1.52)	1 5/8

Gasket RGK

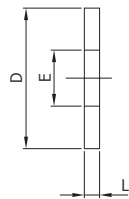

Part No.	R Size (in.)	E	D	L Thickness
		mm (in.)		
RGK-2	1/8	2.3 (0.09)	6.6 (0.26)	0.8 (0.03)
RGK-4	1/4	5.6 (0.22)	11.9 (0.47)	
RGK-8	1/2	11.2 (0.44)	19.8 (0.78)	
RGK-10	5/8	14.7 (0.58)	23.1 (0.91)	
RGK-12	3/4	16.8 (0.66)	29.0 (1.14)	
RGK-16	1	22.6 (0.89)	35.6 (1.40)	

Gasket Retainer RGKT

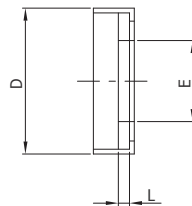

Part No.	R Size (in.)	E	D	L Thickness
		mm (in.)		
RGKT-4	1/4	5.6 (0.22)	12.7 (0.5)	0.8 (0.03)
RGKT-8	1/2	11.2 (0.44)	20.1 (0.79)	
RGKT-12	3/4	16.8 (0.66)	29 (1.14)	
RGKT-16	1	22.6 (0.89)	35.6 (1.4)	

High Flow Gland

RHG

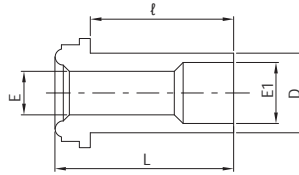

Part No.	R Size (in.)	D Tube Size	Wall Thickness	L	ℓ	E	E1	Working Pressure psig (barg)		
								mm (in.)		
RHG-6L15.2	1/4	3/8	0.89 (0.035)	15.2 (0.60)	10.4 (0.41)	6.4 (0.25)	7.9 (0.31)	3300 (227)	3300 (227)	3300 (227)
RHG-6L30.2				30.2 (1.19)	25.4 (1.00)					
RHG-6L33.3				33.3 (1.31)	28.4 (1.12)					

High Flow Reducer

RHR

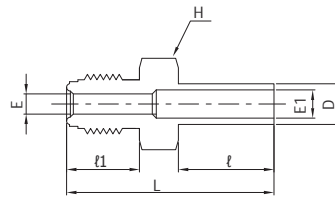

Part No.	R Size	D Tube Size	L	ℓ	ℓ1	E	E1	H, Hex.	Working Pressure psig (barg)		
									mm (in.)		
RHR 4-6	1/4	3/8	42.7 (1.68)	19.1 (0.75)	15.7 (0.62)	6.4 (0.25)	7.9 (0.31)	5/8	3300 (227)	3300 (227)	3300 (227)

Auto Butt Weld High Flow Reducer

RHR-A

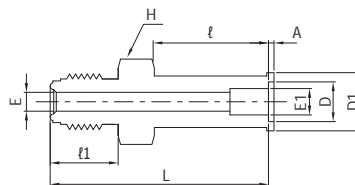

Part No.	R Size (in.)	D Tube Size	L	ℓ	ℓ1	A	E (d)	E1	D1	H, Hex.	Working Pressure psig (barg)		
											mm (in.)		
RHR4-6A	1/4	3/8	43.4 (1.71)	19.1 (0.75)	15.7 (0.62)	0.8 (0.03)	6.4 (0.25)	7.9 (0.31)	10.4 (0.41)	5/8	3300 (227)	3300 (227)	3300 (227)

High Flow Bulkhead Reducer

RHUB

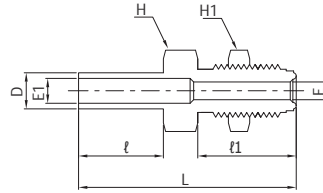

Part No.	R Size (in.)	D Tube Size	A	l	l1	E	E1	Panel Hole Size	Max. Panel Thickness	H, Hex.	H1, Hex.	Working Pressure psig (barg)		
			mm (in.)									in.		NI
RHUB4-6	1/4	3/8	59.9 (2.36)	19.1 (0.75)	33.0 (1.30)	6.4 (0.25)	7.9 (0.31)	15.0 (19/32)	11.2 (0.44)	3/4	3/4	3300 (227)	3300 (227)	3300 (227)

High Flow Union Elbow

RHL

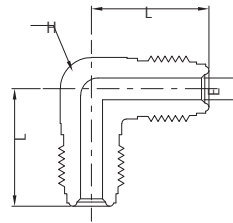

Part No.	R Size	L	E	H, Hex.	Working Pressure psig (barg)		
		mm (in.)			in.	NI	S
RHL-4	1/4	27.2 (1.07)	6.4 (0.25)	1/2	8000 (551)	10000 (689)	6400 (440)

High Flow Union Tee

RHT

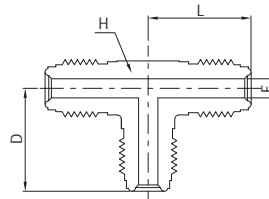

Part No.	R Size (in.)	L	E	H Hex.	Working Pressure psig (barg)		
		mm (in.)			in.	NI	S
RHT-4	1/4	27.2 (1.07)	6.4 (0.25)	1/2	8000 (551)	10000 (689)	6400 (440)

High Flow Female Nut

RHFN

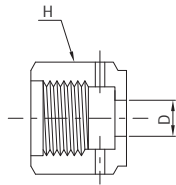

Part No.	R Size (in.)	L	D	H, Hex.
		mm (in.)		in.
RHFN-4SR	1/4	20.6 (0.81)	9.9 (0.39)	3/4
RHFN-4			11.7 (0.46)	

High Flow Male Nut

RHMN

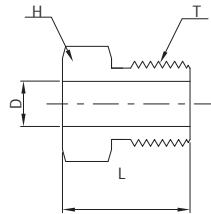

Part No.	R Size (in.)	L	D	H, Hex.
		mm (in.)		in.
RHMN-4SR	1/4	18.0 (0.71)	9.9 (0.39)	5/8

Tube Fitting to Auto Butt Weld Connector

DATW

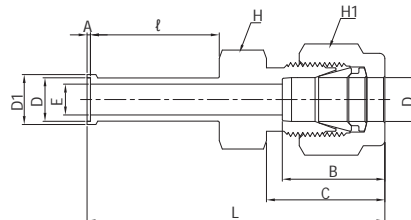

Part No.	D Tube Size	Wall Thickness	L	ℓ	A	B	C	E	D1	H	H1	Working Pressure		
												NI	S	CU
												psig (barg)		
		in.	mm (in.)							in.				
DATW4-4	1/4	0.035	44.2 (1.74)	19.1 (0.75)	0.5 (0.02)	15.2 (0.6)	17.8 (0.7)	4.6 (0.18)	7.4 (0.29)	1/2	9/16	5100 (351)	5100 (351)	5100 (351)
DATW6-6	3/8		46.7 (1.84)			16.8 (0.22)	19.3 (0.76)	7.9 (0.31)	10.4 (0.41)			5/8	11/16	3300 (227)

